

OUR GC×GC MODULATORS: AN OVERVIEW

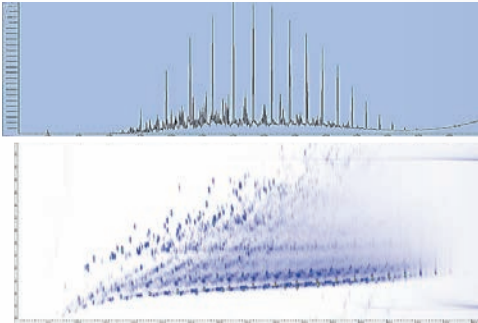

Example of typical diesel oil 1D-GC “signal hump” and enhanced GC×GC separation.

Comprehensive two-dimensional gas chromatography (GC×GC) is a very powerful separation technique in which the carrier gas eluting from a capillary GC column (first dimension) is introduced onto a second capillary column (second dimension) with different but complementary separation mechanism. This way the sample is subject to two different separation processes within a single analysis. This increases remarkably the peak capacity and leads to an enormous resolving power. Compared to a single column separation, GC×GC can provide highly detailed sample characterization and excellent visualization of sample components.

The heart of the system is *the modulator*.

This device continuously fractionates the eluate of the first column into slices and re-injects them into the second dimension, where further separation occurs. Typically eluting peaks from the first dimension are cut by the modulator into 3-5 slices. The separation on the second dimension column is very fast, typically 3-8 seconds.

Nowadays several different types of modulators are available. Some use thermal trapping to modulate the analytes, while others are flow-based.

There is no ideal modulator that is the best choice for all applications. Each design has its own strengths and limitations. Selecting the right modulator is of critical importance because it can affect dramatically the quality of the GC×GC results and the user-

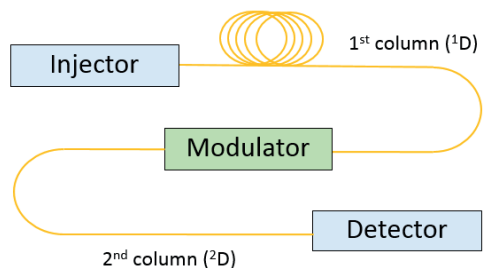

Schematic representation of a GC×GC system.

friendliness of the set-up. This choice should be tailored on your need, taking into consideration the nature of the samples and the types of analyses encountered in your laboratory.

2. FLOW MODULATORS

Flow modulators provide accessible and affordable modulation without the need for cryogenic cooling. The carrier gas eluting from the primary column is separated in modulations which are periodically collected in a dedicated channel and transferred into the second dimension. This is achieved by means of a carefully optimized balance of flows/volumes/times. Thanks to this operational principle, flow modulators are not restricted in terms of analyte volatility.

2.1 Agilent Differential Flow Modulator

The **Agilent Differential Flow Modulator** is based on the **Agilent Capillary Flow Technology (CFT)** and fractionates the carrier gas by simply directing the carrier gas flow.

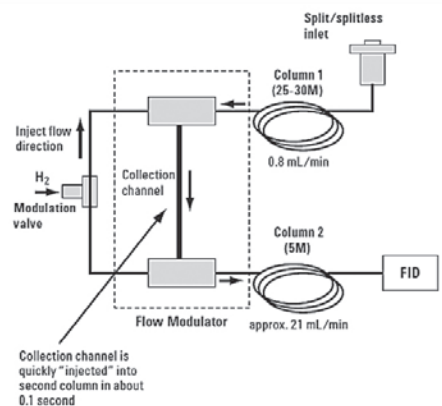
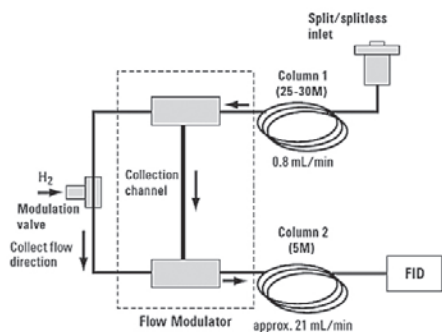

Schematic of the Agilent Direct Flow Modulator in its loading (top) and injection (bottom) modes.

A three-way solenoid valve receives a high supply of gas. The periodic switching of this three-way valve drives the modulator. During the loading step the effluent from the first column fills the collection channel. When the modulation valve is switched a high flow injects the channel content into the second dimension.

Key features:

- Forward fill/flush dynamics.
- No liquid nitrogen required.
- Modulation from C₁+
- Fast re-injection also for heavy compounds.
- Second dimension outlet flow: ± 20mL/min.
- Fixed collection channel.

Strengths:

- Widest sample range, from gases to high boilers.
- Suitable for thermally labile analytes.
- Installation is simple. Cheap and robust set-up.
- Suitable for routine analyses that do not require frequent set-up changes.
- Good for group characterization (no high second dimension resolution needed).

Limitations:

- Restricted in terms of column dimensions and modulation times.
- Coupling to MS requires splitting of the outlet flow (lower sensitivity).
- The forward fill/inject design causes tailing in the second dimension, causing loss in resolution.
- Keen to overload, limited sample capacity range.

EXAMPLE OF APPLICATION

Routine analysis of Total Petroleum Hydrocarbon (TPH) in soil and water.

Environmental laboratories involved in TPH analysis are required to report a total TPH value, an aliphatic value and an aromatic value. When using conventional GC, a lengthy and costly sample preparation is needed because it is not possible to chromatographically distinguish between aliphatics and aromatics.

GC×GC with the Agilent differential flow modulation can be used to remove the time consuming, costly and inaccurate aliphatic/aromatic splitting required for traditional TPH analysis with conventional GC. A second method is not required. The chromatograms can be processed automatically using predefined templates.

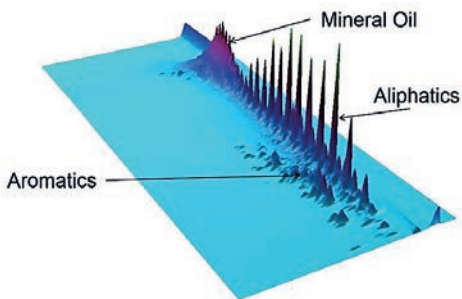
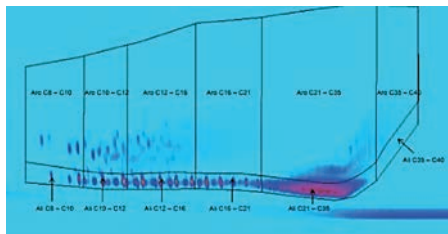

2D plot and 3D visualization of aliphatic/aromatic characterization.

2.2 Reverse Fill/Flush Differential Flow Modulator

The **Agilent Reverse Fill/Flush Flow Modulator** is a second generation flow modulator. The new design reverses flow direction in the channel during the inject part of the modulation cycle. This shows performance benefits over the direct CFT device. The tailing in the second dimension is eliminated, leading to better resolution.

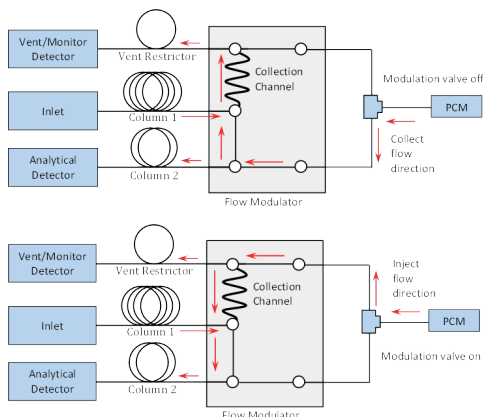

Schematic of the Agilent Reverse Flow Modulator in its loading (top) and injection (bottom) modes.

Key features:

- Reverse fill/flush dynamics.
- No liquid nitrogen needed.
- Modulation from C₁+.
- Fast re-injection also for very heavy compounds.
- Improved modulated peak symmetry.
- Second dimension outlet flow: ± 2-8 mL/min.

Strengths:

- Widest sample range, from gases to high boilers.
- Suitable for thermally labile analytes.
- Improved modulated peak symmetry.
- Improved sample capacity.

Limitations:

- The set-up optimization is complex and laborious.
- Coupling to MS requires splitting of the outlet flow (lower sensitivity).
- More expensive than the Differential Flow Modulator.

EXAMPLE OF APPLICATION

Profiling of gin botanicals by head-space-SPME Arrow-GC×GC-MSD/FID.

Gins are neutral spirit flavoured with various botanicals. The numerous compounds contributing to the aroma and flavour, coupled with the fact that key components can be present at very low level, makes profiling challenging. GC×GC with reverse flow modulation is the ideal analytical technique to unravel sample complexity with focus on the very volatiles. The requirement to split before the MS is used to an advantage by implementing parallel FID detection, so chemical identification and robust quantification can both be achieved.

Unresolved 1D profile and enhanced 2D separation.

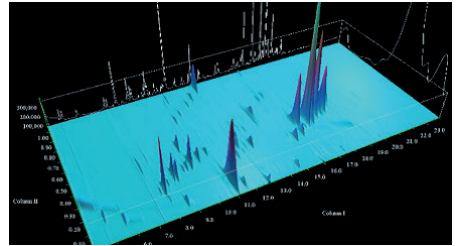
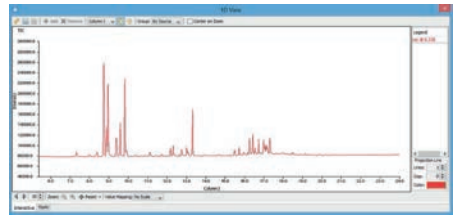

3. THERMAL MODULATORS

Thermal modulators are valve-less devices with minimized dead volume and active sites in the analytic path. The carrier gas is not effected while the analytes are trapped and rapidly re-injected based on temperature, usually by means of precisely controlled cold and hot gas jets. This produces very sharp modulated peaks and thus superior sensitivity and chromatographic resolution. Additional advantages are the possibility to tune freely column dimensions and modulation time and the compatibility to all detectors.

In the *Zoex Loop Modulators* the column is configured in a loop so that only one cold and one hot jet are required for dual-step focusing. This minimizes the hardware necessary while granting excellent performance.



Schematic and picture of a Zoex thermal modulator.



3.1 ZX1 Liquid Nitrogen Cooled Loop Modulation System

The ZX1 model uses a liquid nitrogen bath to cool the gas supplied to the cold jet, granting excellent trapping power.

Key Features:

- Cold Jet reaches -189°C .
- Modulation from C_3 to C_{50} .
- Very sharp modulated peaks.
- Directly compatible with MS detection.
- LN2 supply at 30 psig (206 kPa) to fill the cold-bath bench-top Dewar.
- Auto Fill Unit for unattended operation.
- N_2 consumption for jets: ± 20 L/minute.

Strengths:

- Best sensitivity.
- Best second dimension resolution.
- Provides excellent flexibility, suitable for most applications.
- Simple method development and optimization.
- Directly compatible with MS detection.

Limitations:

- Liquid nitrogen consumption.
- Not suitable for compounds lighter than C_3 and heavier than C_{50} .
- Manual control of modulation time settings.

3.2 ZX2 Closed Cycle Refrigerated Loop Modulation

This model does not require liquid nitrogen for the cold jet but uses a closed cycle refrigeration system, making GC \times GC with thermal modulation more accessible and affordable.

Key Features:

- Cold Jet reaches -91°C .
- Modulation from C_7 to C_{50} .
- Very sharp modulated peaks.
- Directly compatible with MS detection.
- No liquid cryogen required for the cold jet.
- N_2 consumption for jets: ± 20 L/minute.

Strengths:

- Best sensitivity.
- Best second dimension resolution.
- Provides excellent flexibility, suitable for most applications.
- Method development and optimization are very simple.

Limitations:

- Not suitable for compounds lighter than C_7 and heavier than C_{50} .
- Manual control of modulation time settings.

EXAMPLE OF APPLICATION

Improved characterization of highly complex petrochemical samples.

Petrochemical samples include crude and refined products characterized by extremely high complexity. The large number of compounds present, in combination with the very wide range of volatility and polarity, makes detailed chemical profiling challenging at best. GC \times GC with thermal modulation, thanks to its superior chromatographic resolution and flexibility in terms of column set, is the method of choice when attempting to unravel such complex matrices with a good degree of detail. This is for instance the case when focusing on sub-groups made of numerous isomers (e.g. carbon-number breakdown, degree of alkyl substitution, etc.) or even individual compounds.

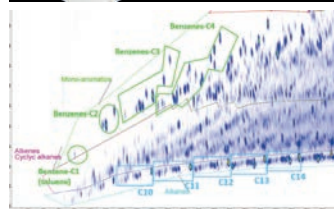
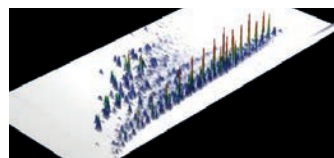

3D view and 2D plot of a diesel oil with example of detailed volatiles characterization.

4. FEATURES OVERVIEW

GCxGC Modulator Comparison

	Direct Flow	Reverse Flow	Zoex ZX1	Zoex ZX2
System Price	\$	\$\$	\$\$\$\$	\$\$\$
Complexity	🔧	🔧🔧🔧	🔧	🔧
Resolution	★★	★★★	★★★★★	★★★★★
Volatility range	Limited by GC	Limited by GC	C ₃ -C ₅₀	C ₇ -C ₅₀
MS	not supported	limited	✓✓	✓✓
Application	analyte groups	specific analytes	research or unknowns	research or unknowns

5. CONCLUSIONS

Every modulator type has key features that should be taken into consideration when selecting the right GC×GC set-up. The choice of the right set-up should be tailored to your applications to find the perfect modulator for your laboratory.

Flow modulators are robust and their operation is cheap, features that make them strong candidates for routine analyses that require minimal changes. They can handle a wide volatility range, from gases to heavy compounds. The direct flow modulator is suitable for group analysis that does not require the best second dimension resolution. The reverse flow modulator is more complex in terms of operation but grants improved flexibility and performance.

The Zoex thermal modulators offer superior chromatographic resolution and allow unraveling samples of particularly high complexity. Additionally, they are extremely flexible as well as easy and quick to optimize. Like all thermal modulators the volatility range is limited, but the ZX1 cryogenic model is suitable for volatiles as well. They are ideal for laboratories that need to focus on very complex samples and to work with a wide range of different applications.



JSB International

Parklaan 54a
5613 BH Eindhoven
Nederland
T +31 (0)40 251 47 53
E info@go-jsb.com
I www.go-jsb.com

JSB United Kingdom and Ireland

UNIT 25 | Graylands Estate
Langhurstwood Road, Horsham
West Sussex RH12 4QD | UK
T +44 (0)162 885 4566
E info@go-jsb.co.uk
I www.go-jsb.co.uk

JSB Benelux

Apolloweg 2B
8239 DA Lelystad
Nederland
T +31 (0)320 87 00 18
E info@go-jsb.com
I www.go-jsb.nl

JSB Deutschland GmbH

Betriebsstätte
Max-Planck-Straße 4
D-47475 Kamp-Lintfort
T +49 (0)2842 9280 799
E +49 (0)2842 9732 638
I www.go-jsb.de

JSB is an authorised partner of:
 Agilent Technologies
Premium Solution Partner